

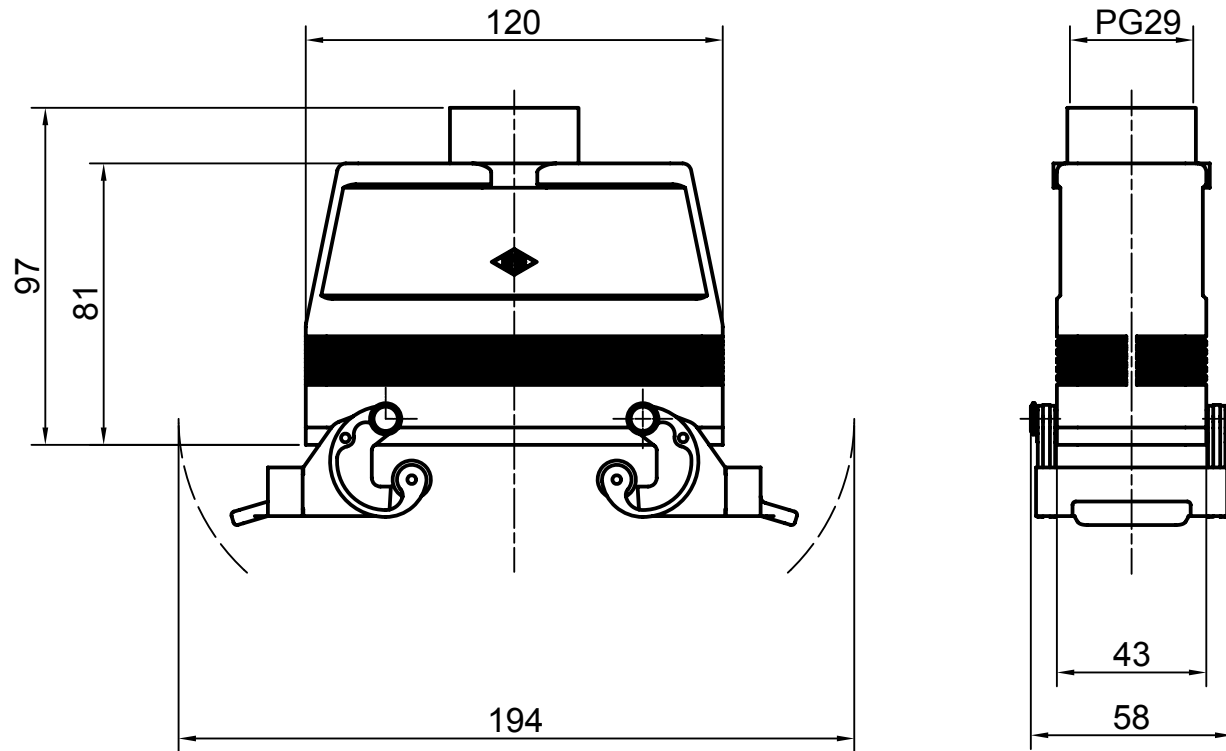

Diritti riservati

All rights reserved



Date 04.01.2007	CMAV 16 G29	Scale	
Sign.	hood top entry with 2 lev. PG29 ins.	1:2	